

规格尺寸

PEDS150R-PM-X

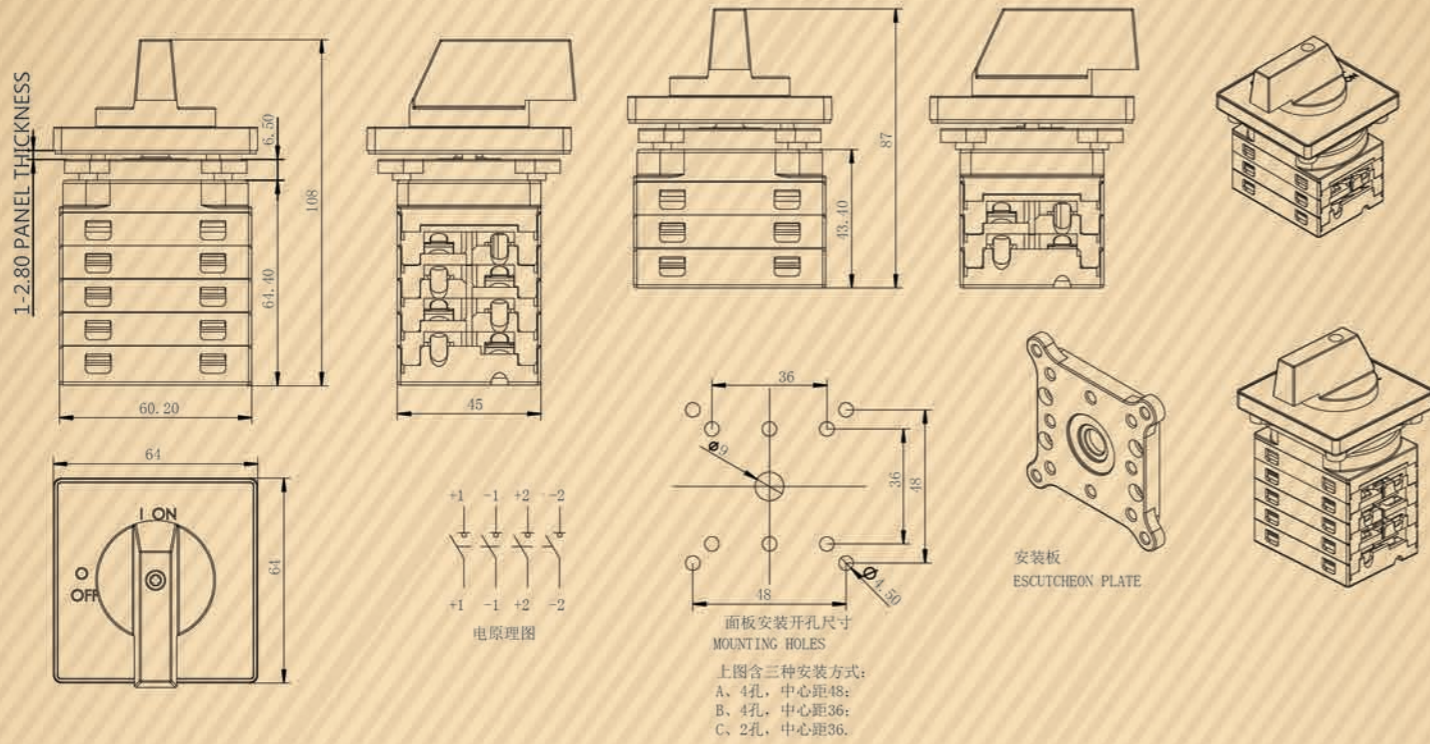

PEDS150R-PM(R)-X-Model

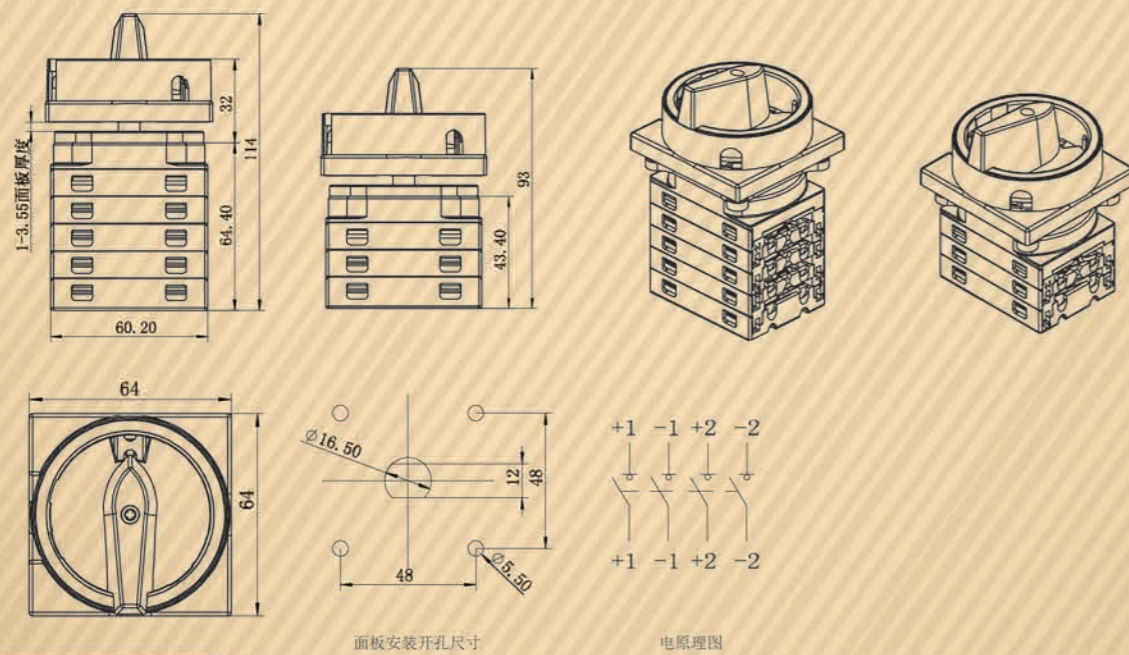

面板安装直流开关

PEDS150R-PM-X

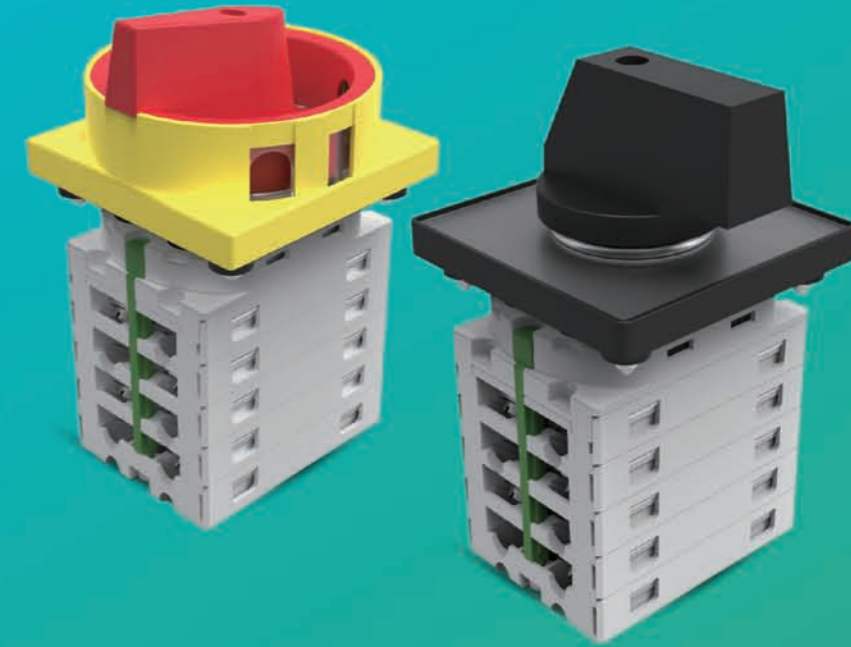



产品特点













1. 结构紧凑，模块化设计，2-8级可用型号，满足多种场合需要；
2. 面板安装方式安装牢固，良好的密封设计，采用了进口密封件，安装能使机器整体达到IP66等级；
3. 高速的“开-关”切换机构，采用储能弹簧，当储能到达弹簧动作点的时候（人工操作手柄达到切换位置之前），机构即快速实现切换，极大的缩短直流电弧的产生与存在时间，使得最大通断切换时间小于5ms；
4. 触点自清洁设计，旋转触点护架能有效清除触点表面产生的积垢，使触点保持良好的接触性能，减少发热与磨损，改善导通性能，降低了直流开关的电阻和能耗，延长了开关的寿命；
5. 面板面积48mm\*48mm，占用逆变器底板面积小，有利于逆变器底板安装多个接口；
6. 采用进口的绝缘等级UL94V-0的阻燃材料，在环境温度-40℃~+70℃区间产品可以满载工作；
7. 额定直流电压1500V的设计，且通过了IEC60947-3, UL508I, GB14048.3等多个国际认证。

技术参数

以下数据按IEC60947-3,UL508i,GB14048.3,使用类别DC21A/DC21B

主要参数		Type	PM16	PM25	PM32
额定绝缘电压	$U_i$	V	1500	1500	1500
额定发热电流	$I_{the}$	A	16	25	32
额定冲击耐受电压	$U_{imp}$	V	8000	8000	8000
额定短时耐受电流 (1s)	$I_{cw}$	2, 4, 6, 8	800	900	1000
		2H, 3H, 4H	1300	1500	1700
额定短路接通能力	$I_{cm}$	2, 4, 6, 8	800	900	1000
		2H, 3H, 4H	1300	1500	1700
额定限制短路电流	$I_{cc}$	A	5000	5000	5000
最大熔丝规格	$g_1$ (gG)	A	40	63	80
最大电缆截面积 (包括跳接线)					
单根线或标准		mm <sup>2</sup>	4-16	4-16	4-16
软线		mm <sup>2</sup>	4-10	4-10	4-10
软线 (+多股电缆端)		mm <sup>2</sup>	4-10	4-10	4-10
扭矩					
接线端子M4螺钉紧固扭矩		Nm		1.2-1.3	
面板安装螺钉ST4.2 (304不锈钢) 紧固扭矩		Nm		0.8-0.9	
单孔安装螺母M16 (塑料) 紧固扭矩		Nm		NA	
旋钮M3螺钉紧固扭矩		Nm		0.5-0.7	
开关转换扭矩		Nm		0.9-1.9	
每个接触对最大功率损耗					
2		W	0.8	2	3
4		W	1.6	4	6
6		W	2.4	6	9
8		W	3.2	8	12
2H		W	0.4	1	1.5
3H		W	0.6	1.5	2.25
4H		W	0.8	2	3
通用参数					
安装方法	面板安装				
旋钮样式	A	B	C		
					
开关旋钮位置	12点位置关, 3点位置开 (可选9点开, 12点开)				
机械寿命	10,000				
直流极数	2 or 4 (6/8极可选)				
触点间距离 (极间)	mm	8			
操作温度	°C	-40 to +70			
储存温度	°C	-40 to +85			
污染等级	2				
过电压类别	III				
轴和安装螺钉的IP等级	IP66				

技术参数

以下数据按IEC60947-3,UL508i,GB14048.3,使用类别DC21A/DC21B								串联的级数	回路	型号	触点配置
500V	600V	700V	800V	900V	1000V	1200V	1500V				
9	6	4.5	3	2.5	1.5	/	/	1	1	PEDS150R-PM16-1	
11	8	6	4	3	2	/	/	1	1	PEDS150R-PM25-1	
13	10	7.5	5	4	2.5	/	/	1	1	PEDS150R-PM32-1	
16	16	16	16	13	9	6	3	2	1	PEDS150R-PM16-2	
25	25	23	20	16	11	8	4	2	1	PEDS150R-PM25-2	
32	32	27	23	20	13	10	5	2	1	PEDS150R-PM32-2	
16	16	16	16	13	9	6	3	2	2	PEDS150R-PM16-3	
25	25	23	20	16	11	8	4	2	2	PEDS150R-PM25-3	
32	32	27	23	20	13	10	5	2	2	PEDS150R-PM32-3	
29	29	16	16	13	9	6	3	2	1	PEDS150R-PM16-2H	
45	45	23	20	16	11	8	4	2	1	PEDS150R-PM25-2H	
58	50	27	23	20	13	10	5	2	1	PEDS150R-PM32-2H	
16	16	16	16	13	9	6	3	2	2	PEDS150R-PM16-4	
25	25	23	20	16	11	8	4	2	2	PEDS150R-PM25-4	
32	32	27	23	20	13	10	5	2	2	PEDS150R-PM32-4	
16	16	16	16	16	16	16	16	4	1	PEDS150R-PM16-4S	
25	25	25	25	25	25	25	20	4	1	PEDS150R-PM25-4S	
32	32	32	32	32	32	32	23	4	1	PEDS150R-PM32-4S	
16	16	16	16	16	16	16	16	4	1	PEDS150R-PM16-4T	
25	25	25	25	25	25	25	20	4	1	PEDS150R-PM25-4T	
32	32	32	32	32	32	32	23	4	1	PEDS150R-PM32-4T	
16	16	16	16	16	16	16	16	4	1	PEDS150R-PM16-4B	
25	25	25	25	25	25	25	20	4	1	PEDS150R-PM25-4B	
32	32	32	32	32	32	32	23	4	1	PEDS150R-PM32-4B	
16	16	16	16	13	9	6	3	2	3	PEDS150R-PM16-6	
25	25	23	20	16	11	8	4	2	3	PEDS150R-PM25-6	
32	32	27	23	20	13	10	5	2	3	PEDS150R-PM32-6	
29	29	29	29	29	29	12	9	3	1	PEDS150R-PM16-3H	
45	45	38	38	38	38	14	11	3	1	PEDS150R-PM25-3H	
58	50	45	45	45	45	16	13	3	1	PEDS150R-PM32-3H	
16	16	16	16	13	9	6	3	2	4	PEDS150R-PM16-8	
25	25	23	20	16	11	8	4	2	4	PEDS150R-PM25-8	
32	32	27	23	20	13	10	5	2	4	PEDS150R-PM32-8	
29	29	29	29	29	29	29	16	4	1	PEDS150R-PM16-4H	
45	45	45	45	45	45	45	20	4	1	PEDS150R-PM25-4H	
58	58	58	58	58	58	50	23	4	1	PEDS150R-PM32-4H	