

## 軍規系列圓型連接器：



MMS - ①①①①②③④④-⑤⑤ ⑥

MMS：圓型軍規連接器代碼。

標示①：3108A：90度彎式插頭。

：3106A：直式插頭。

：3102A：盒式方盤安裝插座。

：3101A：中繼插座。

：3100A：牆式方盤安裝插座

：3057A：線夾。

標示②：A：一體成型。

標示③：絕緣體材料：無標記(聚丁橡膠絕緣體)。

標示④：殼體尺寸編號。

標示⑤：插針孔組排列代碼。

標示⑥：P：插針。 S：插孔。



## MMS-C-5015軍規系列產品資料

### 產品簡介

該系列產品採用螺紋式連接系統，並具有體積小、密度高、耐環境性能好、接觸可靠等優點，按照軍標MIL-C-5015系列的技術要求生產，產品廣泛應用於航空、航天、伺服電機以及其它電子設備之間的電氣連接。

### 介質耐壓和工作電壓

等級	介質耐壓 (V)	工作電壓	
		直流 (DCV)	交流 (ACV)
儀器	1000	250	200
A	2000	700	500
D	2800	1250	900
E	3500	1750	1250
B	4500	2450	1750
C	7000	4200	300

注：儀器、A、D、E、B、C與絕緣體孔位排列相對應

接觸體		針接觸體直徑 (mm)	額定電流 (A)	接觸電阻		導線規格		
代號	焊杯孔直徑 (mm)			試驗電流 (A)	允許壓降 (mV)	AWG	線平方數 (mm <sup>2</sup> )	外徑 (mm)
16#	Φ1.8	Φ1.6	13	20	21	22#~16#	≤1.3	Φ1.7~Φ3.3
12#	Φ2.9	Φ2.4	23	35	20	14#~12#	≤3.5	Φ2.9~Φ4.3
8#	Φ5.3	Φ3.6	46	60	12	10#~8#	≤8.0	Φ4.2~Φ6.4
4#	Φ8.5	Φ5.7	80	110	10	6#~4#	≤22.0	Φ7.0~Φ9.4
0#	Φ11.8	Φ9.1	150	200	10	2~0#	≤50.0	Φ10.6~Φ14.0

### 材料及表面處理

	材料	表面處理
殼體	鋁合金	單綠色鍍鋅鈍化
絕緣體	氯丁橡膠	
接觸體	銅	鍍金、銀

### 技術參數

絕緣電阻	≥5000MΩ
環境溫度	-55°C~+125°C
機械壽命	≥500次

### 接觸體插拔力

代號	最大(kg)	平均(KG)	最小(KG)
16#	1.36	0.68	0.0566
12#	2.27	1.58	0.085
8#	4.54	1.37	0.142
4#	6.80	2.5	0.2835
0#	9.07	5	0.425

## 14S 插孔 S (插針 P) 孔組排列

	14S-9  A 2-16#	14S-7  A 3-16#	14S-2  4-16#	14S-5  5-16#	14S-6  6-16#
規格	2芯 2-16#	3芯 3-16#	4芯 4-16#	5芯 5-16#	6芯 6-16#
	MMS-3108A 14S-9S(P)	MMS-3108A 14S-7S(P)	MMS-3108A 14S-2S(P)	MMS-3108A 14S-5S(P)	MMS-3108A 14S-6S(P)
	MMS-3106A 14S-9S(P)	MMS-3106A 14S-7S(P)	MMS-3106A 14S-2S(P)	MMS-3106A 14S-5S(P)	MMS-3108A 14S-6S(P)
	MMS-3102A 14S-9S(P)	MMS-3102A 14S-7S(P)	MMS-3102A 14S-2S(P)	MMS-3102A 14S-5S(P)	MMS-3102A 14S-6S(P)
	MMS-3101A 14S-9S(P)	MMS-3101A 14S-7S(P)	MMS-3101A 14S-2S(P)	MMS-3101A 14S-5S(P)	MMS-3101A 14S-6S(P)
	MMS-3100A 14S-9S(P)	MMS-3100A 14S-7S(P)	MMS-3100A 14S-2S(P)	MMS-3100A 14S-5S(P)	MMS-3100A 14S-6S(P)

接觸體		針接觸體直徑 (mm)	額定電流 (A)	接觸電阻		導線規格		
代號	焊杯孔直徑 (mm)			試驗電流 (A)	允許壓降 (mV)	AWG	線平方數 (mm)	外徑 (mm)
16#	Φ1.8	Φ1.6	13	20	21	22#~16#	≤1.3	Φ1.7~Φ3.3

接觸體插拔力			
代號	最大(kg)	平均(KG)	最小(KG)
16#	1.36	0.68	0.0566

## 16S 插孔 S (插針 P) 孔組排列

	<p>16S-4 2-16#</p>	<p>16S-10 3-16#</p>	<p>16S-8 5-16#</p>	<p>16S-1 7-16#</p>	
規格	2芯 2-16#	3芯 3-16#	5芯 5-16#	7芯 7-16#	
	MMS-3108A 16S-4S(P)	MMS-3108A 16S-10S(P)	MMS-3108A 16S-8S(P)	MMS-3108A 16S-1S(P)	
	MMS-3106A 16S-4S(P)	MMS-3106A 16S-10S(P)	MMS-3106A 16S-8S(P)	MMS-3106A 16S-1S(P)	
	MMS-3102A 16S-4S(P)	MMS-3102A 16S-10S(P)	MMS-3102A 16S-8S(P)	MMS-3102A 16S-1S(P)	
	MMS-3101A 16S-4S(P)	MMS-3101A 16S-10S(P)	MMS-3101A 16S-8S(P)	MMS-3101A 16S-1S(P)	
	MMS-3100A 16S-4S(P)	MMS-3100A 16S-10S(P)	MMS-3100A 16S-8S(P)	MMS-3100A 16S-1S(P)	

接觸體		針接觸體直徑 (mm)	額定電流 (A)	接觸電阻		導線規格		
代號	焊杯孔直徑 (mm)			試驗電流 (A)	允許壓降 (mV)	AWG	線平方數 (mm)	外徑 (mm)
16#	Φ1.8	Φ1.6	13	20	21	22#~16#	≤1.3	Φ1.7~Φ3.3

接觸體插拔力			
代號	最大(kg)	平均(KG)	最小(KG)
16#	1.36	0.68	0.0566







## 18 插孔 S (插針 P) 孔組排列

	<p>18-3 2-12# D</p>	<p>18-10 4-12# D</p>	<p>18-12 6-16# D</p>	<p>18-8 1-12# 7-16# D</p>	<p>18-1 10-16# D</p>
規格	2芯 2-12#	4芯 4-12#	6芯 6-16#	7芯 7-16# 1-12#	10芯 10-16#
	MMS-3108A 18-3S(P)	MMS-3108A 18-10S(P)	MMS-3108A 18-12S(P)	MMS-3108A 18-8S(P)	MMS-3108A 18-1S(P)
	MMS-3106A 18-3S(P)	MMS-3106A 18-10S(P)	MMS-3106A 18-12S(P)	MMS-3106A 18-8S(P)	MMS-3106A 18-1S(P)
	MMS-3102A 18-3S(P)	MMS-3102A 18-10S(P)	MMS-3102A 18-12S(P)	MMS-3102A 18-8S(P)	MMS-3102A 18-1S(P)
	MMS-3101A 18-3S(P)	MMS-3101A 18-10S(P)	MMS-3101A 18-12S(P)	MMS-3101A 18-8S(P)	MMS-3101A 18-1S(P)
	MMS-3100A 18-3S(P)	MMS-3100A 18-10S(P)	MMS-3100A 18-12S(P)	MMS-3100A 18-8S(P)	MMS-3100A 18-1S(P)

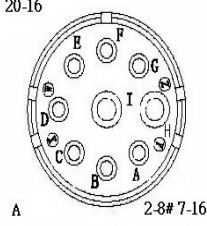
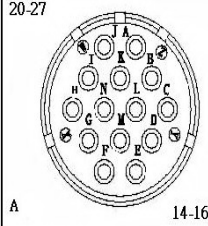
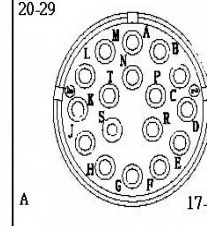
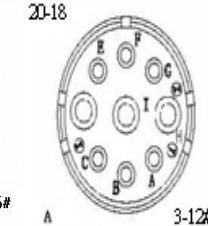
接觸體		針接觸體直徑 (mm)	額定電流 (A)	接觸電阻		導線規格		
代號	焊杯孔直徑 (mm)			試驗電流 (A)	允許壓降 (mV)	AWG	線平方數 (mm)	外徑 (mm)
16#	Φ1.8	Φ1.6	13	20	21	22#~16#	≤1.3	Φ1.7~Φ3.3
12#	Φ2.9	Φ2.4	23	35	20	14#~12#	≤3.5	Φ2.9~Φ4.3

接觸體插拔力			
代號	最大(kg)	平均(KG)	最小(KG)
16#	1.36	0.68	0.0566
12#	2.27	1.58	0.085





## 20 插孔 S (插針 P) 孔組排列

	20-16  A 2-8# 7-16#	20-27  A 14-16	20-29  A 17-16#	20-18  A 3-12# 6-16#
規格	9芯 2-8# 7-16#	14芯 14-16#	17芯 17-16#	9芯 3-12# 6-16#
	MMS-3108A 20-16S(P)	MMS-3108A 20-27S(P)	MMS-3108A 20-29S(P)	MMS-3108A 20-18S(P)
	MMS-3106A 20-16S(P)	MMS-3106A 20-27S(P)	MMS-3106A 20-29S(P)	MMS-3106A 20-18S(P)
	MMS-3102A 20-16S(P)	MMS-3102A 20-27S(P)	MMS-3102A 20-29S(P)	MMS-3102A 20-18S(P)
	MMS-3101A 20-16S(P)	MMS-3101A 20-27S(P)	MMS-3101A 20-29S(P)	MMS-3101A 20-18S(P)
	MMS-3100A 20-16S(P)	MMS-3100A 20-27S(P)	MMS-3100A 20-29S(P)	MMS-3100A 20-18S(P)

接觸體		針接觸體直徑 (mm)	額定電流 (A)	接觸電阻		導線規格		
代號	焊杯孔直徑 (mm)			試驗電流 (A)	允許壓降 (mV)	AWG	線平方數 (mm)	外徑 (mm)
16#	Φ1.8	Φ1.6	13	20	21	22#~16#	≤1.3	Φ1.7~Φ3.3
12#	Φ2.9	Φ2.4	23	35	20	14#~12#	≤3.5	Φ2.9~Φ4.3
8#	Φ5.3	Φ3.6	46	60	12	10#~8#	≤8.0	Φ4.2~Φ6.4

接觸體插拔力			
代號	最大(kg)	平均(KG)	最小(KG)
16#	1.36	0.68	0.0566
12#	2.27	1.58	0.085
8#	4.54	1.37	0.142





## 20 插孔 S (插針 P) 孔組排列

規格	2芯 2-8#	3芯 3-8#	4芯 4-12#	7芯 7-12#	8芯 8-16#
	MMS-3108A 20-23S(P)	MMS-3108A 20-19S(P)	MMS-3108A 20-4S(P)	MMS-3108A 20-15S(P)	MMS-3108A 20-7S(P)
	MMS-3106A 20-23S(P)	MMS-3106A 20-19S(P)	MMS-3106A 20-4S(P)	MMS-3106A 20-15S(P)	MMS-3106A 20-7S(P)
	MMS-3102A 20-23S(P)	MMS-3102A 20-19S(P)	MMS-3102A 20-4S(P)	MMS-3102A 20-15S(P)	MMS-3102A 20-7S(P)
	MMS-3101A 20-23S(P)	MMS-3101A 20-19S(P)	MMS-3101A 20-4S(P)	MMS-3101A 20-15S(P)	MMS-3101A 20-7S(P)
	MMS-3100A 20-23S(P)	MMS-3100A 20-19S(P)	MMS-3100A 20-4S(P)	MMS-3100A 20-15S(P)	MMS-3100A 20-7S(P)

接觸體		針接觸體直徑 (mm)	額定電流 (A)	接觸電阻		導線規格		
代號	焊杯孔直徑 (mm)			試驗電流 (A)	允許壓降 (mV)	AWG	線平方數 (mm)	外徑 (mm)
16#	Φ1.8	Φ1.6	13	20	21	22#~16#	≤1.3	Φ1.7~Φ3.3
12#	Φ2.9	Φ2.4	23	35	20	14#~12#	≤3.5	Φ2.9~Φ4.3
8#	Φ5.3	Φ3.6	46	60	12	10#~8#	≤8.0	Φ4.2~Φ6.4

接觸體插拔力			
代號	最大(kg)	平均(KG)	最小(KG)
16#	1.36	0.68	0.0566
12#	2.27	1.58	0.085
8#	4.54	1.37	0.142

## 22 插孔 S (插針 P) 孔組排列





規格	5芯 2-8# 3-16#	3芯 3-8#	4芯 4-8#	8芯 8-12#	19芯 19-16#
	MMS-3108A 22-12S(P)	MMS-3108A 22-2S(P)	MMS-3108A 22-22S(P)	MMS-3108A 22-23S(P)	MMS-3108A 22-14S(P)
	MMS-3106A 22-12S(P)	MMS-3106A 22-2S(P)	MMS-3106A 22-22S(P)	MMS-3106A 22-23S(P)	MMS-3106A 22-14S(P)
	MMS-3102A 22-12S(P)	MMS-3102A 22-2S(P)	MMS-3102A 22-22S(P)	MMS-3102A 22-23S(P)	MMS-3102A 22-14S(P)
	MMS-3101A 22-12S(P)	MMS-3101A 22-2S(P)	MMS-3101A 22-22S(P)	MMS-3101A 22-23S(P)	MMS-3101A 22-14S(P)
	MMS-3100A 22-12S(P)	MMS-3100A 22-2S(P)	MMS-3100A 22-22S(P)	MMS-3100A 22-23S(P)	MMS-3100A 22-14S(P)

接觸體		針接觸體直徑 (mm)	額定電流 (A)	接觸電阻		導線規格		
代號	焊杯孔直徑 (mm)			試驗電流 (A)	允許壓降 (mV)	AWG	線平方數 (mm)	外徑 (mm)
16#	Φ1.8	Φ1.6	13	20	21	22#~16#	≤1.3	Φ1.7~Φ3.3
12#	Φ2.9	Φ2.4	23	35	20	14#~12#	≤3.5	Φ2.9~Φ4.3
8#	Φ5.3	Φ3.6	46	60	12	10#~8#	≤8.0	Φ4.2~Φ6.4

接觸體插拔力			
代號	最大(kg)	平均(KG)	最小(KG)
16#	1.36	0.68	0.0566
12#	2.27	1.58	0.085
8#	4.54	1.37	0.142









## 24 插孔 S (插針 P) 孔組排列

規格	7芯 7-8#	9芯 6-12# 3-8#	16芯 16-16#	16芯 14-16# 2-12#	24芯 24-16#
	MMS-3108A 24-10S(P)	MMS-3108A 24-11S(P)	MMS-3108A 24-5S(P)	MMS-3108A 24-7S(P)	MMS-3108A 24-28S(P)
	MMS-3106A 24-10S(P)	MMS-3106A 24-11S(P)	MMS-3106A 24-5S(P)	MMS-3106A 24-7S(P)	MMS-3106A 24-28S(P)
	MMS-3102A 24-10S(P)	MMS-3102A 24-11S(P)	MMS-3102A 24-5S(P)	MMS-3102A 24-7S(P)	MMS-3102A 24-28S(P)
	MMS-3101A 24-10S(P)	MMS-3101A 24-11S(P)	MMS-3101A 24-5S(P)	MMS-3101A 24-7S(P)	MMS-3101A 24-28S(P)
	MMS-3100A 24-10S(P)	MMS-3100A 24-11S(P)	MMS-3100A 24-5S(P)	MMS-3100A 24-7S(P)	MMS-3100A 24-28S(P)

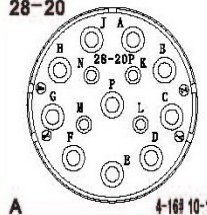
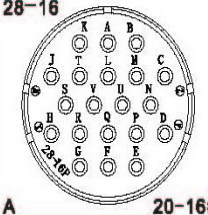
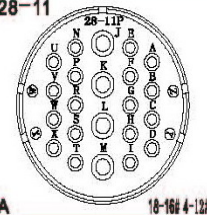
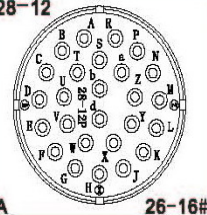
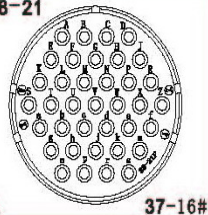
接觸體		針接觸體直徑 (mm)	額定電流 (A)	接觸電阻		導線規格		
代號	焊杯孔直徑 (mm)			試驗電流 (A)	允許壓降 (mV)	AWG	線平方數 (mm)	外徑 (mm)
16#	Φ1.8	Φ1.6	13	20	21	22#~16#	≤1.3	Φ1.7~Φ3.3
12#	Φ2.9	Φ2.4	23	35	20	14#~12#	≤3.5	Φ2.9~Φ4.3
8#	Φ5.3	Φ3.6	46	60	12	10#~8#	≤8.0	Φ4.2~Φ6.4

接觸體插拔力			
代號	最大(kg)	平均(KG)	最小(KG)
16#	1.36	0.68	0.0566
12#	2.27	1.58	0.085
8#	4.54	1.37	0.142

## 28 插孔 S (插針 P) 孔組排列

	28-20  A 4-16# 10-12#	28-16  A 20-16#	28-11  A 18-16# 4-12#	28-12  A 26-16#	28-21  A 37-16#
規格	14芯 10-12# 4-10#	20芯 20-16#	22芯 4-12# 18-16#	26芯 26-16#	37芯 37-16#
	MMS-3108A 28-20S(P)	MMS-3108A 28-16S(P)	MMS-3108A 28-11S(P)	MMS-3108A 28-12S(P)	MMS-3108A 28-21S(P)
	MMS-3106A 28-20S(P)	MMS-3106A 28-16S(P)	MMS-3106A 28-11S(P)	MMS-3106A 28-12S(P)	MMS-3106A 28-21S(P)
	MMS-3102A 28-20S(P)	MMS-3102A 28-16S(P)	MMS-3102A 28-11S(P)	MMS-3102A 28-12S(P)	MMS-3102A 28-21S(P)
	MMS-3101A 28-20S(P)	MMS-3101A 28-16S(P)	MMS-3101A 28-11S(P)	MMS-3101A 28-12S(P)	MMS-3101A 28-21S(P)
	MMS-3100A 28-20S(P)	MMS-3100A 28-16S(P)	MMS-3100A 28-11S(P)	MMS-3100A 28-12S(P)	MMS-3100A 28-21S(P)

接觸體		針接觸體直徑 (mm)	額定電流 (A)	接觸電阻		導線規格		
代號	焊杯孔直徑 (mm)			試驗電流 (A)	允許壓降 (mV)	AWG	線平方數 (mm <sup>2</sup> )	外徑 (mm)
16#	Φ1.8	Φ1.6	13	20	21	22#~16#	≤1.3	Φ1.7~Φ3.3
12#	Φ2.9	Φ2.4	23	35	20	14#~12#	≤3.5	Φ2.9~Φ4.3
8#	Φ5.3	Φ3.6	46	60	12	10#~8#	≤8.0	Φ4.2~Φ6.4

接觸體插拔力			
代號	最大(kg)	平均(KG)	最小(KG)
16#	1.36	0.68	0.0566
12#	2.27	1.58	0.085
8#	4.54	1.37	0.142

# MMS 3100A-\*\*\*與MMS 3101A-\*\*\*尺寸圖

## 3100A 鑄式方盤安裝插座

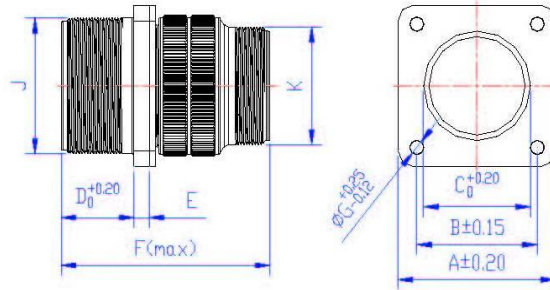

殼體號	A	B	C	D	E	F	G	J螺紋	K螺紋
14S	30.18	23.01	17.45	14.30	3.00	42.87	3.05	7/8-20UNEF-2B	3/4-20UNEF-2A
16S	32.54	24.61	20.75	14.30	3.00	42.87	3.05	1-20UNEF-2B	7/8-20UNEF-2A
18	34.93	26.97	23.90	19.05	4.00	52.37	3.70	1-1/8-18UNEF-2B	1-20UNEF-2A
20	38.10	29.36	26.95	19.05	4.00	55.57	3.70	1-1/4-18UNEF-2B	1-3/16-18UNEF-2A
22	41.28	31.75	30.15	19.05	4.00	55.57	3.70	1-3/8-18UNEF-2B	1-3/16-18UNEF-2A
24	44.45	34.93	33.30	19.05	4.00	58.72	3.70	1-1/2-18UNEF-2B	1-7/16-18UNEF-2A
28	50.80	39.67	38.90	19.05	4.00	58.72	3.70	1-3/4-18UNEF-2B	1-7/16-18UNEF-2A

## 3101A 中繼接頭

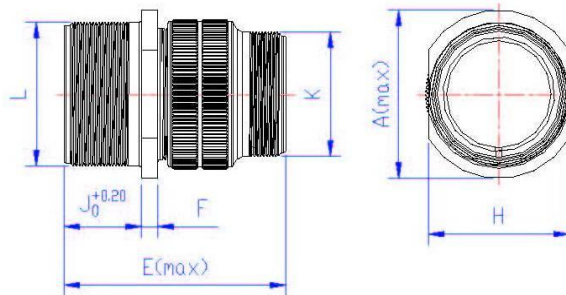

殼體號	A	E	ΦH	F	J	L螺紋	K螺紋
14S	29.36	42.87	17.45	3.00	14.50	7/8-20UNEF-2B	3/4-20UNEF-2A
16S	31.75	42.87	20.75	3.00	14.50	1-20UNEF-2B	7/8-20UNEF-2A
18	34.13	55.50	23.90	4.00	19.05	1-1/8-18UNEF-2B	1-20UNEF-2A
20	37.31	55.50	26.95	4.00	19.05	1-1/4-18UNEF-2B	1-3/16-18UNEF-2A
22	40.48	55.50	30.15	4.00	19.05	1-3/8-18UNEF-2B	1-3/16-18UNEF-2A
24	43.66	55.50	33.30	4.00	19.05	1-1/2-18UNEF-2B	1-7/16-18UNEF-2A
28	50.01	55.50	38.90	4.00	19.05	1-3/4-18UNEF-2B	1-7/16-18UNEF-2A

## MMS 3102A-\*\*\*與MMS 3057A-\*\*\*尺寸圖

### 3102A 盒式方盤安裝插座

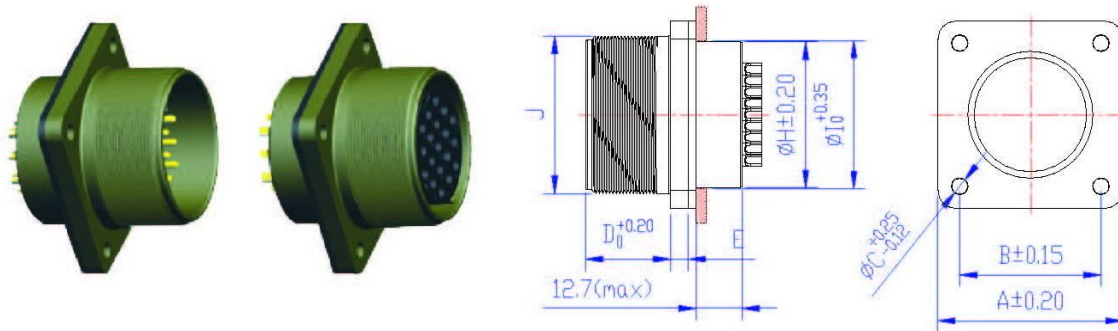

殼體號	A	B	C	D	E	ΦH (3102)	ΦI (3102)	ΦH (3102E)	ΦI (3102E)	J螺紋
14S	30.18	23.01	3.05	14.30	3.00	23.01	23.83	21.00	21.80	7/8-20UNEF-2B
16S	32.54	24.61	3.05	14.30	3.00	26.21	26.97	24.00	24.80	1-20UNEF-2B
18	34.93	26.97	3.70	19.05	4.00	29.36	30.18	25.10	25.90	1-1/8-18UNEF-2B
20	38.10	29.36	3.70	19.05	4.00	32.56	33.30	29.30	30.00	1-1/4-18UNEF-2B
22	41.28	31.75	3.70	19.05	4.00	35.71	36.53	32.10	33.00	1-3/8-18UNEF-2B
24	44.45	34.93	3.70	19.05	4.00	38.91	39.67	37.00	37.80	1-1/2-18UNEF-2B
28	50.80	39.67	3.70	19.05	4.00	45.26	46.02	43.00	43.80	1-3/4-18UNEF-2B

### 3057 線夾

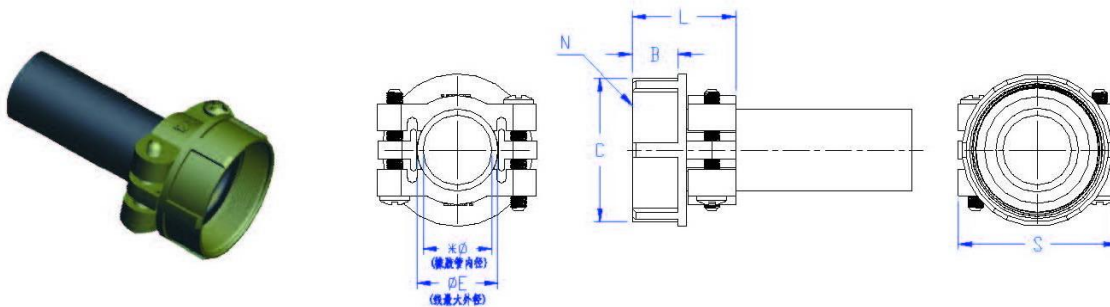

件號	殼體號	橡膠管	B	C	E	L	S	Φ	N螺紋
3057-4A	10SL	-4	11.20	20.60	7.90	20.60	22.20	5.59	3/4-20UNEF-2A
3057-6A	14S	-6	12.00	24.60	11.10	22.20	27.00	7.92	7/8-20UNEF-2A
3057-8A	16S	-8	12.80	27.80	14.30	23.80	29.40	11.10	1-20UNEF-2A
3057-10A	18	-10	12.50	30.20	14.00	23.50	31.50	14.27	1-3/16-18UNEF-2A
3057-12A	20、22	-12	12.50	35.00	20.00	24.00	37.00	15.88	1-3/16-18UNEF-2A
3057-16A	24、28	-16	12.50	42.10	23.80	26.20	42.90	19.05	1-7/16-18UNEF-2A
3057-20A	32	-20	14.00	44.50	31.80	27.80	51.60	23.80	1-7/16-18UNEF-2A

# MMS 3108A-\*\*\*與MMS 3106A-\*\*\*尺寸圖

## 3106A 直式插頭

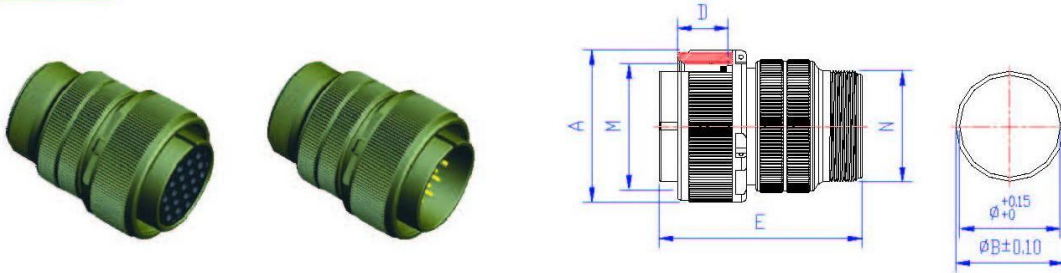

殼體號	ΦA	ΦB	ΦC	D	E	M螺紋	N螺紋
14S	29.36	17.15	13.37	13.49	42.87	7/8-20UNEF-2B	3/4-20UNEF-2A
16S	31.75	20.45	16.54	13.49	42.87	1-20UNEF-2B	7/8-20UNEF-2A
18	34.13	23.62	19.72	18.26	52.37	1-1/8-18UNEF-2B	1-20UNEF-2A
20	37.31	26.67	23.68	18.26	55.57	1-1/4-18UNEF-2B	1-3/16-18UNEF-2A
22	40.48	29.85	26.07	18.26	55.57	1-3/8-18UNEF-2B	1-3/16-18UNEF-2A
24	43.66	33.02	29.24	18.26	58.72	1-1/2-18UNEF-2B	1-7/16-18UNEF-2A
28	50.01	38.61	34.80	18.26	58.72	1-3/4-18UNEF-2B	1-7/16-18UNEF-2A

## 3108A 90° 彎式插頭

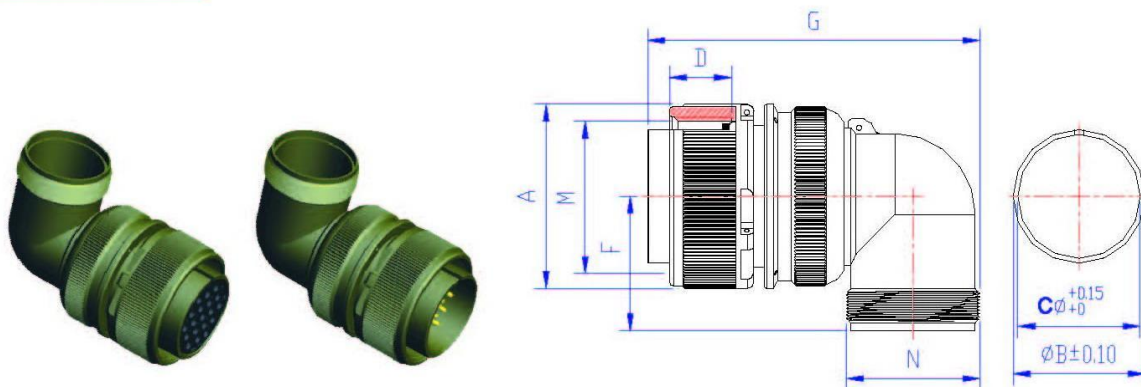

殼體號	ΦA	ΦB	ΦC	D	F	G	M螺紋	N螺紋
14S	29.00	17.15	13.37	13.49	23.00	53.97	7/8-20UNEF-2B	3/4-20UNEF-2A
16S	31.50	20.45	16.54	13.49	24.00	60.32	1-20UNEF-2B	7/8-20UNEF-2A
18	34.50	23.62	19.72	18.26	27.00	68.27	1-1/8-18UNEF-2B	1-20UNEF-2A
20	37.50	26.67	23.68	18.26	30.00	76.98	1-1/4-18UNEF-2B	1-3/16-18UNEF-2A
22	41.00	29.85	26.07	18.26	30.00	86.51	1-3/8-18UNEF-2B	1-3/16-18UNEF-2A
24	44.00	33.02	29.24	18.26	32.00	86.51	1-1/2-18UNEF-2B	1-7/16-18UNEF-2A
28	50.50	38.61	34.80	18.26	33.60	93.98	1-3/4-18UNEF-2B	1-7/16-18UNEF-2A