

# 纯臻品质 匠心智造

金宏电器

致力于为客户提供卓越的、  
高附加值产品体验!

更多相关产品信息请登录  
[www.wzjh.cc](http://www.wzjh.cc)

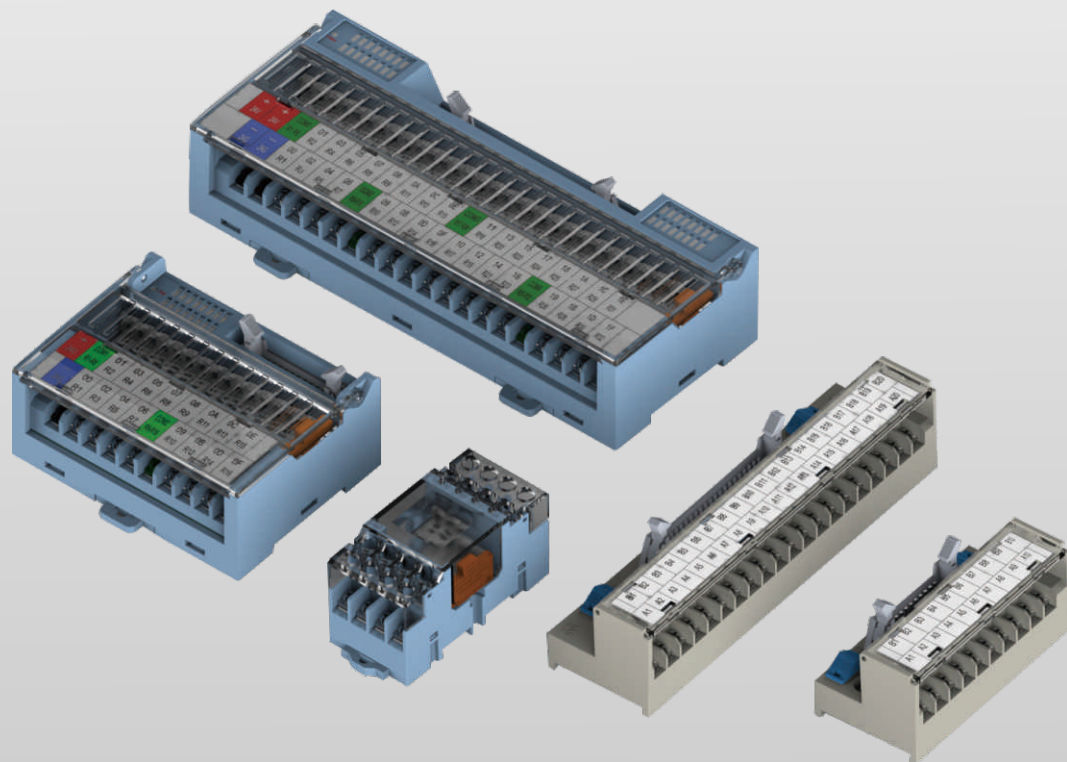

Ac Isolated Switch  
Automation Components

I/O 端子台&继电器盘

温州金宏电器有限公司

Wenzhou  
Jinhong Electrical Appliance  
Co.,Ltd

/



Industrial Control

# Products Contents

# 产品目录

Security,  
we want you to be more  
comprehensive.

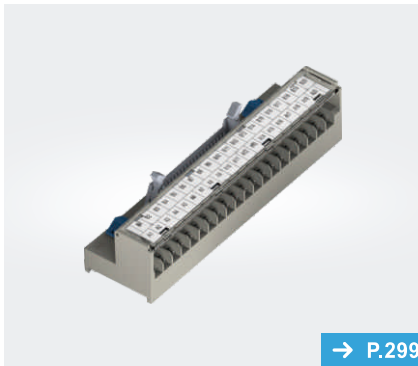

JHTB端子台  
Ac Isolated Switch



宏发电气  
Ac Isolated Switch



松下 (PANASONIC)  
Ac Isolated Switch

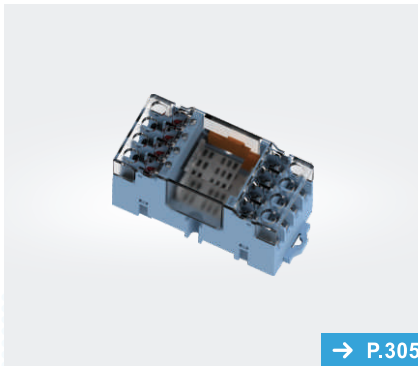

JHF4T—系列  
Ac Isolated Switch

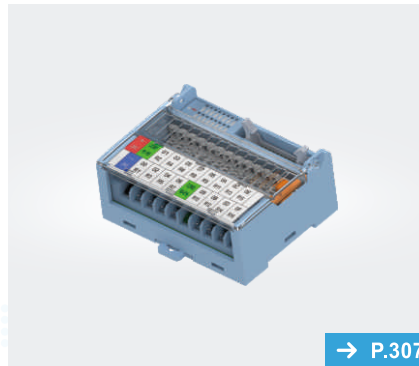

JHF16C—系列  
Ac Isolated Switch

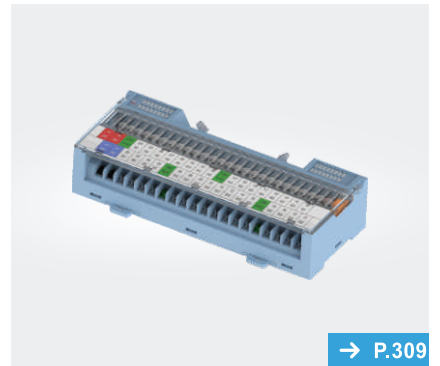

JHF32C—系列  
Ac Isolated Switch

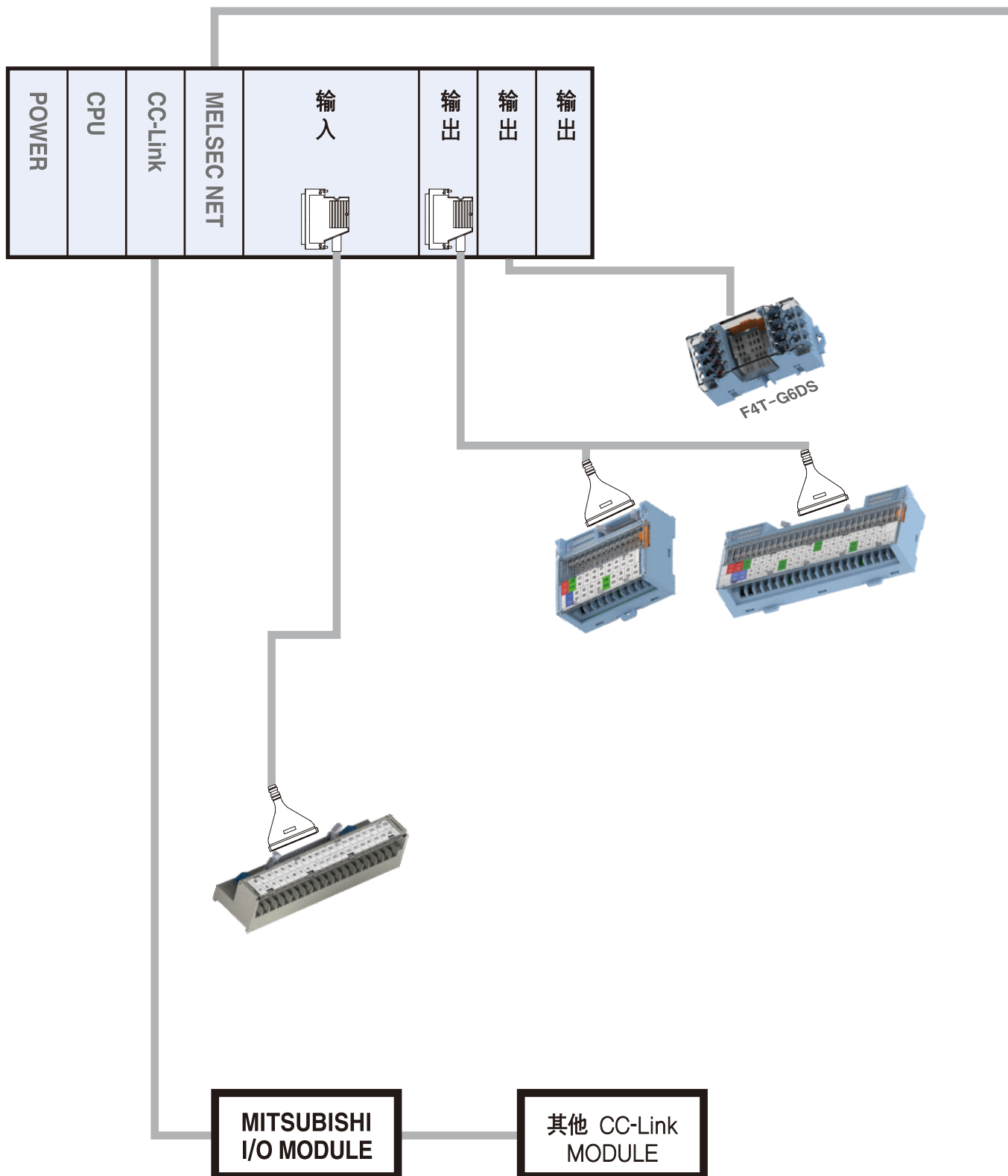

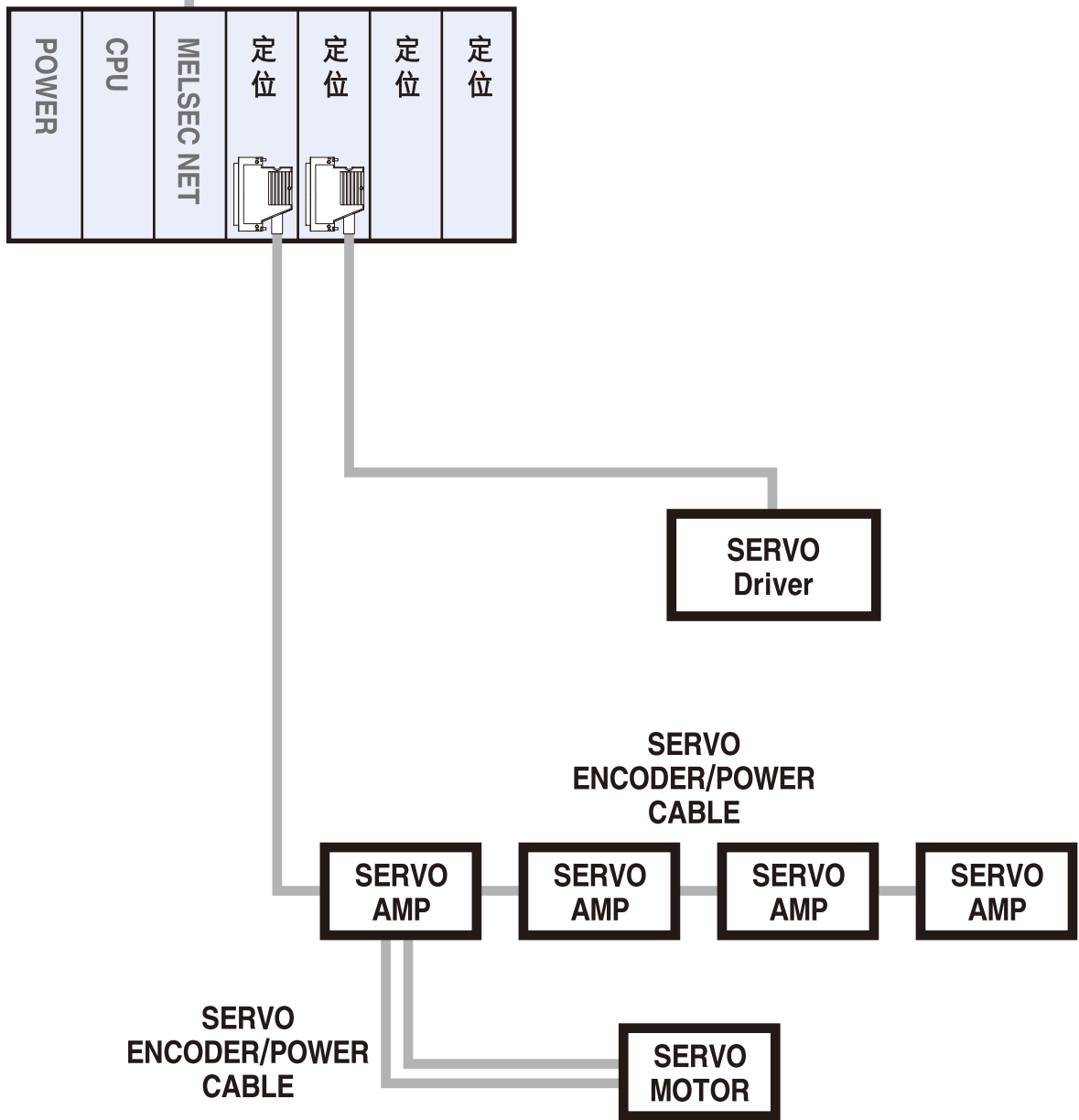

NEW

# JHTB端子台

(7.0mm Pitch, 接口标准端子台)

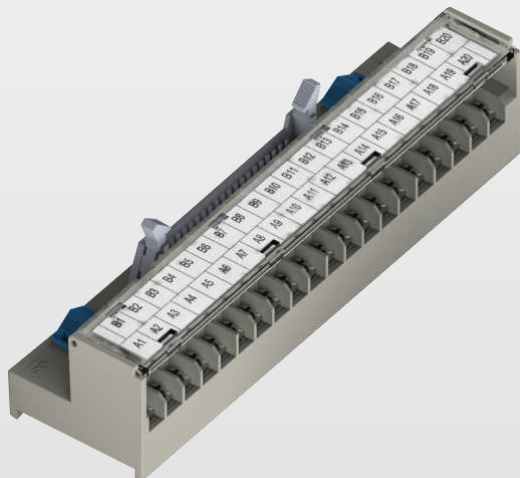

## ■ 特性 / Features

- Y型端子和0型端子通用
- 结构安全及耐环境
- 适用于连接器式PLC及专用控制器的I/O
- 节省空间
- 操作和维修方便

公司电子样本浏览手机网站

[www.wzjh.cc](http://www.wzjh.cc)

了解公司最新动态及相关信息与成功应用情况



微信二维码

[www.wzjh.cc](http://www.wzjh.cc)

扫一扫, 更精彩...



## ■ 型号命名 / Select Code

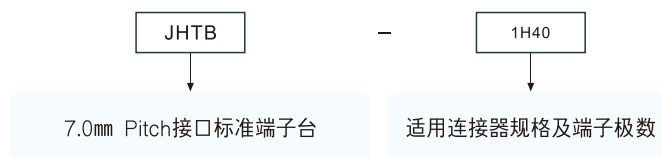

## ■ 规格 / Specifications

型号	极数	装配连接器	产品尺寸(W×D, mm)
JHTB-1H20	20	MIL Standard	80×40
JHTB-1H40	40	MIL Standard	148×40
JHTB-1H50	50	MIL Standard	183×40

※ 装配的连接器的产品, 有可能不事先通知而变更。

## ■ 额定参数/Rating

额定电压	125V AC / 24V DC
额定电流	1A
绝缘电阻	100MΩ以上 (DC 500V)
耐电压	AC 500V 1min
适用电线	1.25mm <sup>2</sup> /MAX
端子Screw	M3×10L
Screw扭矩	1.2N·m (12Kgf·cm)
环境温度	-10℃ ~ +50℃ (无外路)

## ■ 材料/Material

端子台和保护盖	Modified PPO
保护盖	Polycarbonate

## ■ 使用压接端子规格/Specifications

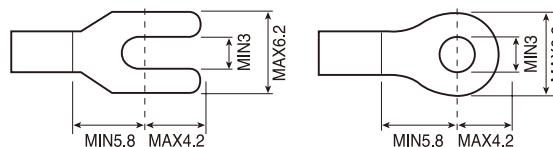

### JHTB-1H20

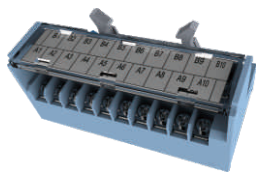

CE

外观图

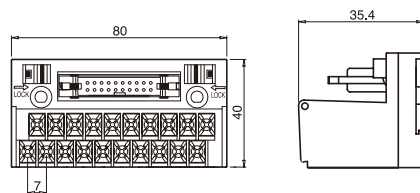

接线图

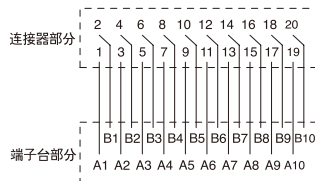

### JHTB-1H40

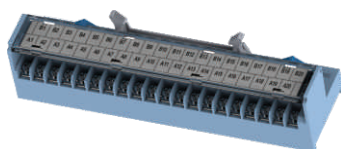

CE

外观图

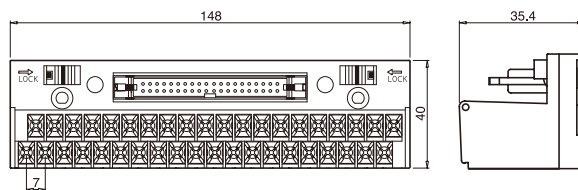

接线图

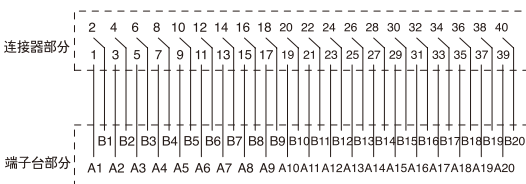

### JHTB-1H50

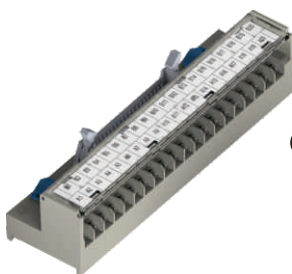

CE

外观图

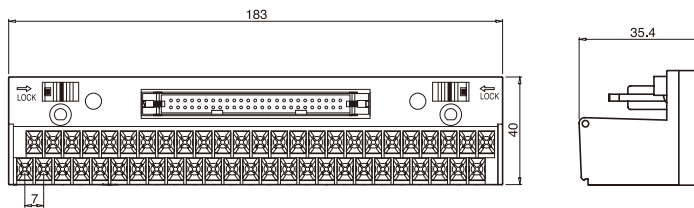

接线图

